

HIERROS

ALUMINIOS

FF

S.A.

*PLANOS DE PERFIL
TECHOS DESLIZANTES*

TECHO MOVIL

HIERROS

ALUMINIOS

FF

S.A.

HIERROS

ALUMINIOS

FF

S.A.

PLANOS DE PERFIL TECHOS DESLIZANTES

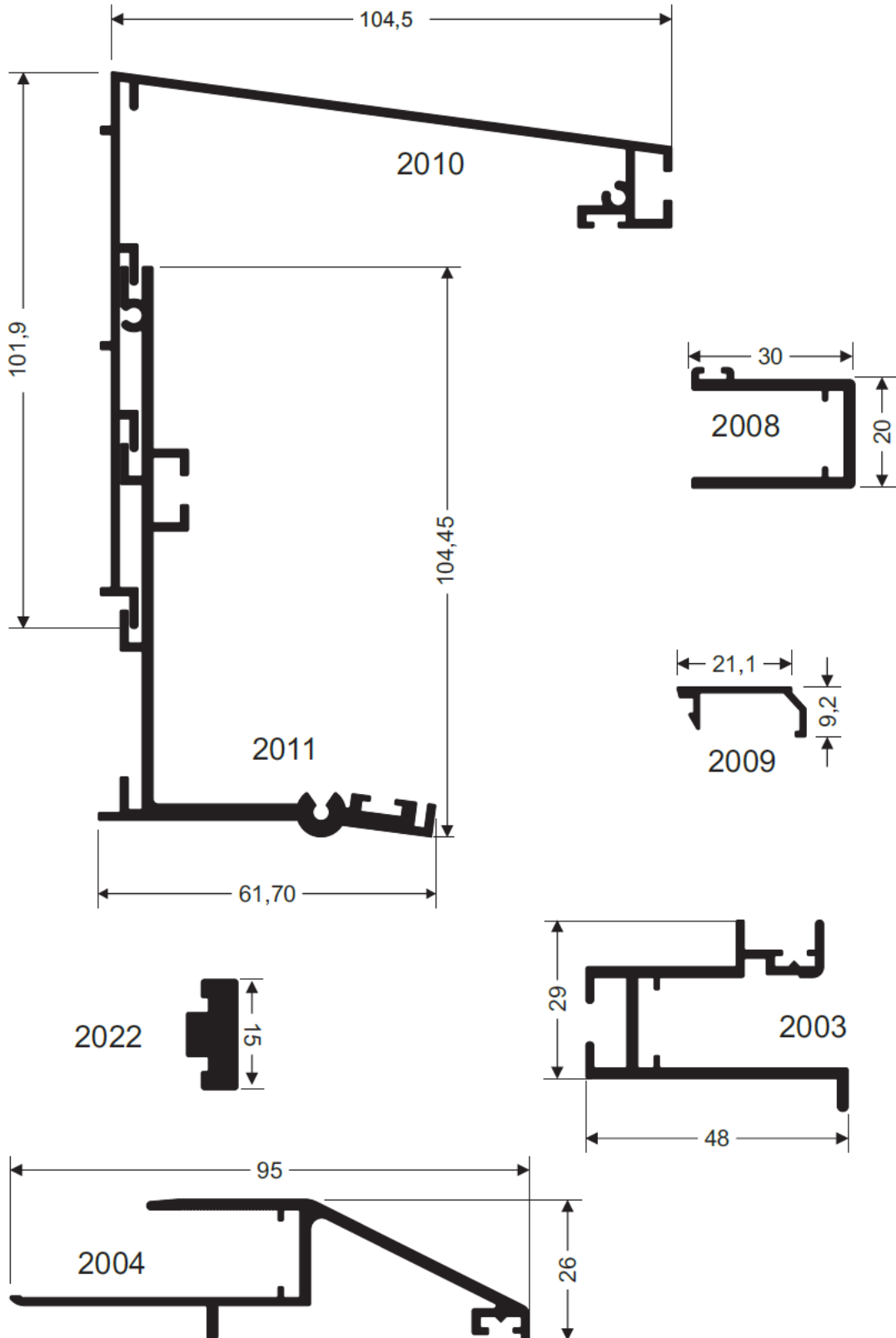

HIERROS

ALUMINIOS

FF

S.A.

PLANOS DE PERFIL
TECHOS DESLIZANTES

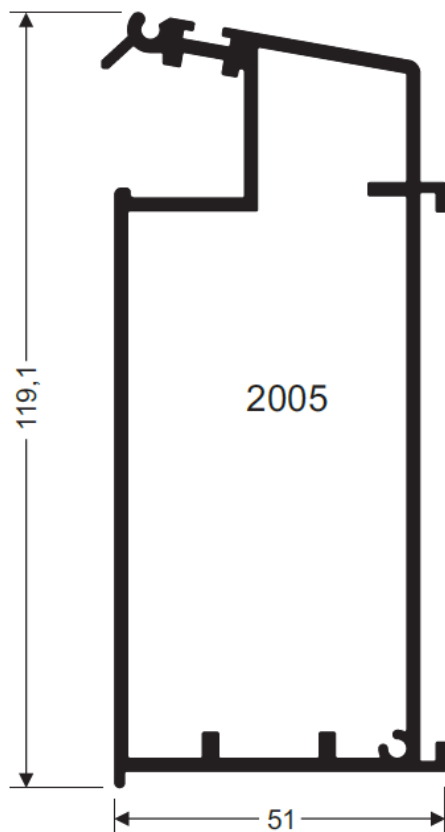
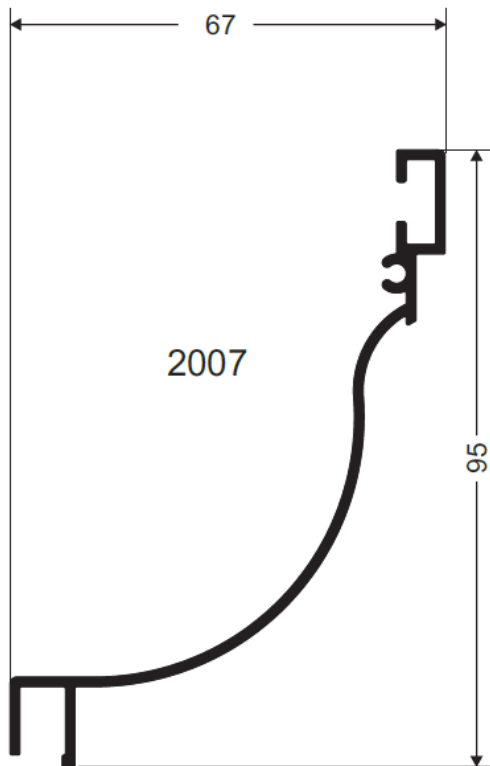
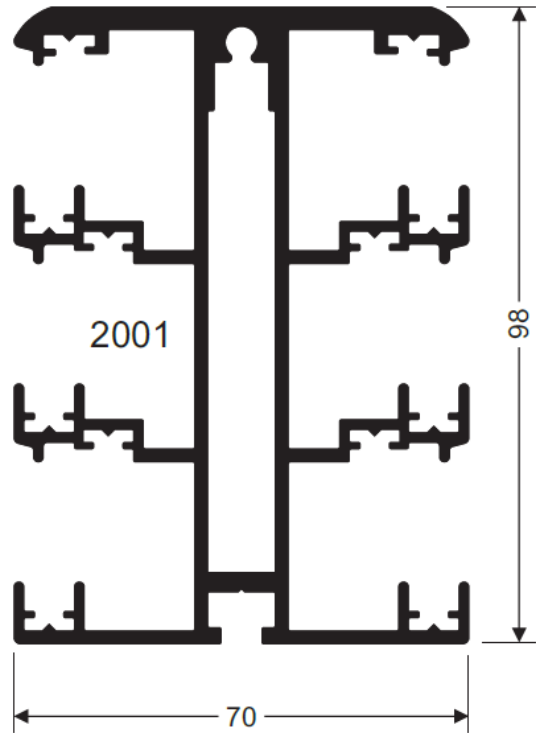
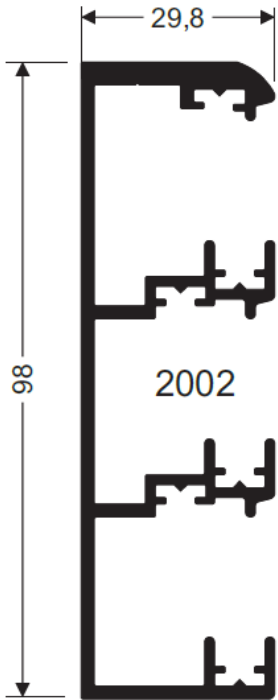

HIERROS

ALUMINIOS

FF

S.A.

PLANOS DE PERFIL
TECHOS DESLIZANTES

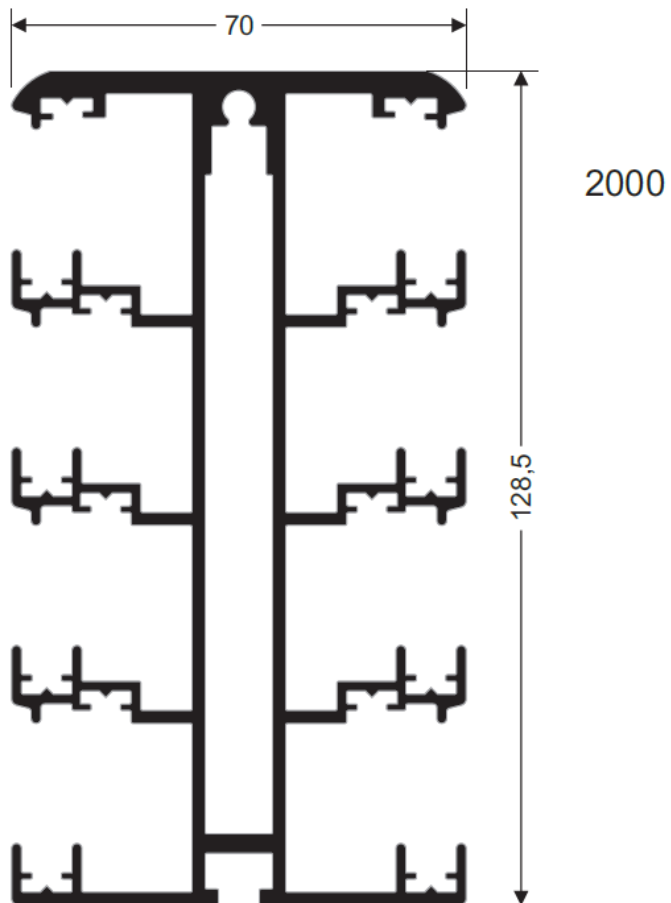
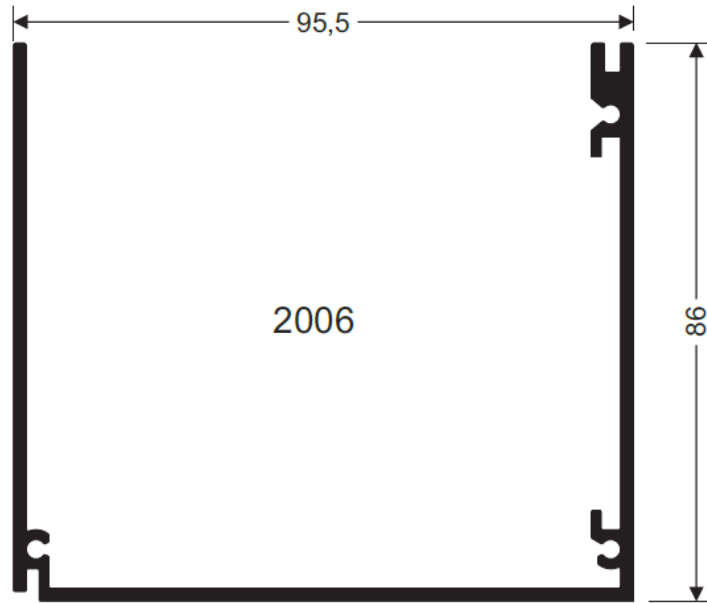

HIERROS

ALUMINIOS

FF

S.A.

PLANOS DE PERFIL
TECHOS DESLIZANTES

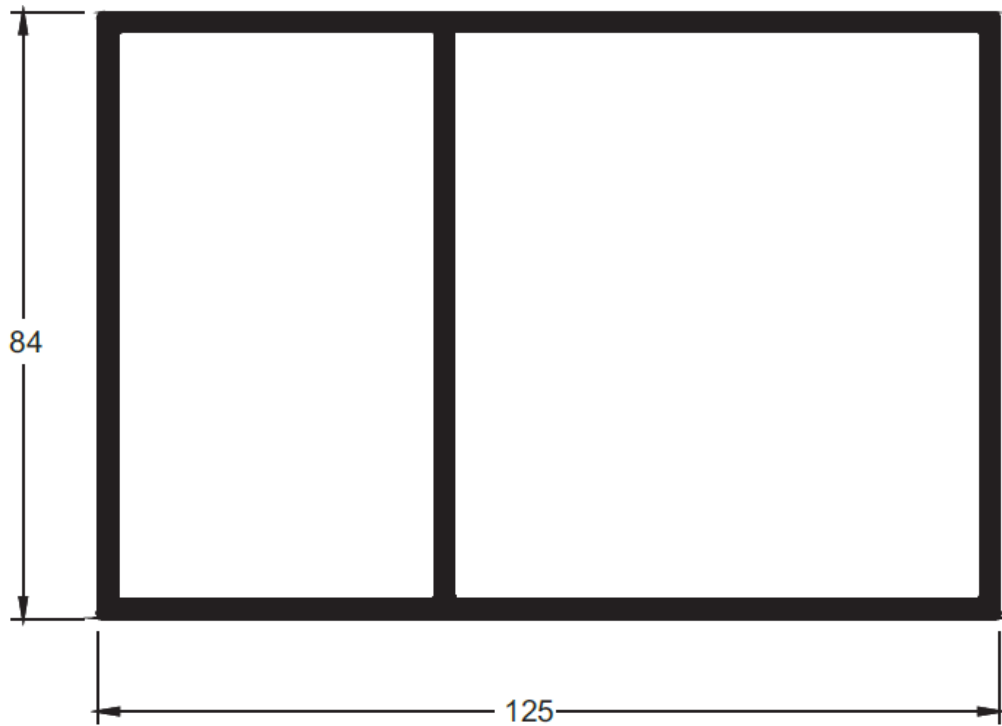

2014

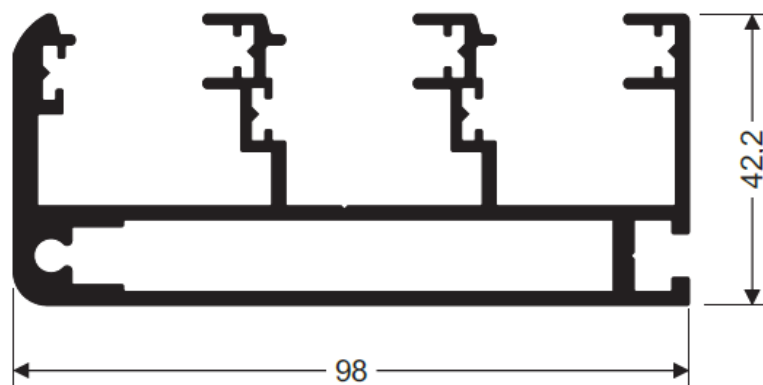

2016

HIERROS

ALUMINIOS

FF

S.A.

PLANOS DE PERFIL
TECHOS DESLIZANTES

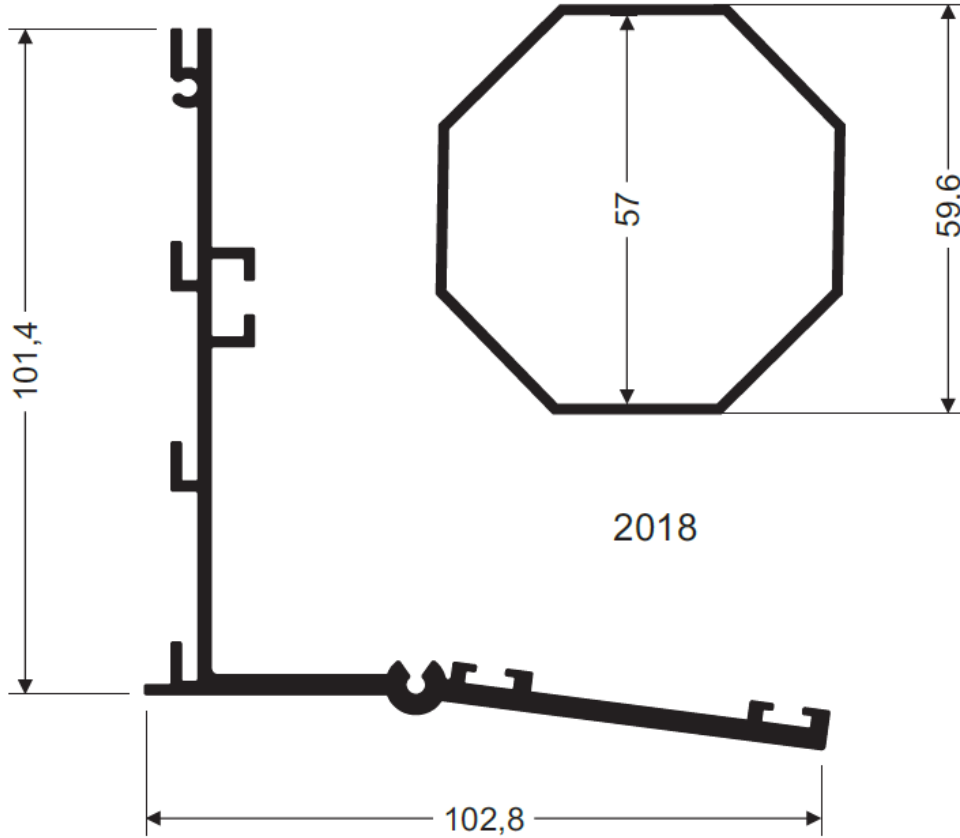

2018

2017

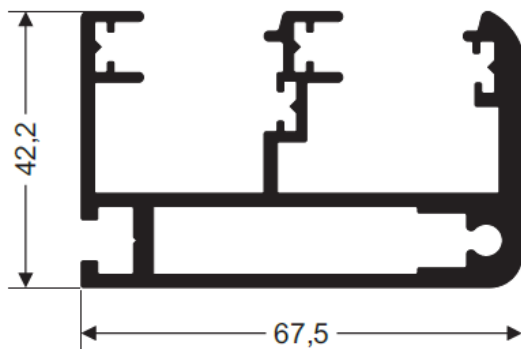

2020

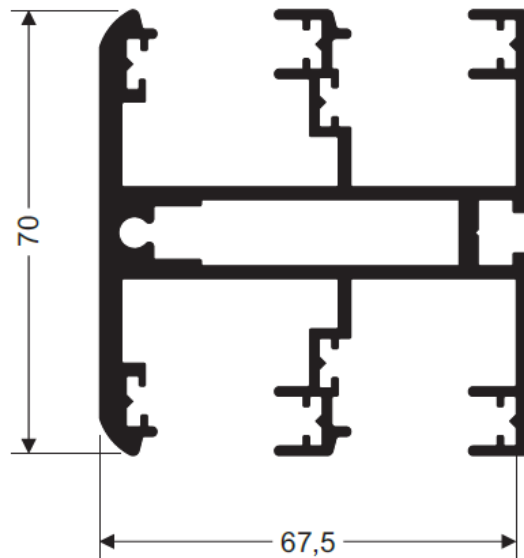

2021





HIERROS

ALUMINIOS

FF

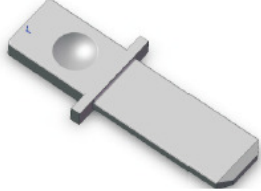
S.A.

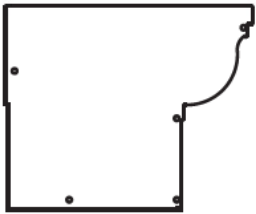
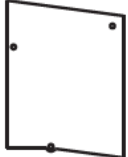
PLANOS DE PERFIL TECHOS DESLIZANTES

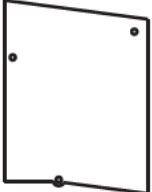
	Ref.	DENOMINACION
	TM01	Patín.
	TM02	Tirador 2 Tornillos inoxidable
	TM03	Pértiga
	TM04	Tapa Canalón 5 tornillos inoxidable
	TM16	Tapa Canalón 2 carriles 3 tornillos inoxidable
	TM05	Tapa Canalón 3 carriles 3 tornillos inoxidable
	TM06	Tapa Canalón 4 carriles 3 tornillos inoxidable







HIERROS

ALUMINIOS

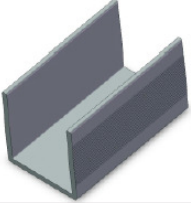
FF

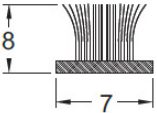
S.A.

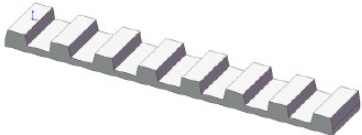
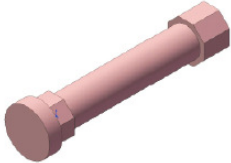
PLANOS DE PERFIL TECHOS DESLIZANTES

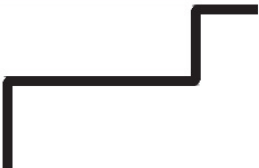
	Ref.	DENOMINACION
	TM07	Anclaje poste
	TM08	Goma Cobija
	TM09	Felpudo de 8X7mm
	TM10	Tope
	TM11	Embudo
	TM12	Correa T10 12mm
	TM13	Motor con acople octogonal y mando
	TM14	Goma hoja inferior ref:2008
	TM15	Sujeción hoja superior

HIERROS

ALUMINIOS

FF

S.A.

PLANOS DE PERFIL TECHOS DESLIZANTES

2 Carriles manual

3 Carriles manual
y motorizado

4 Carriles manual
y motorizado

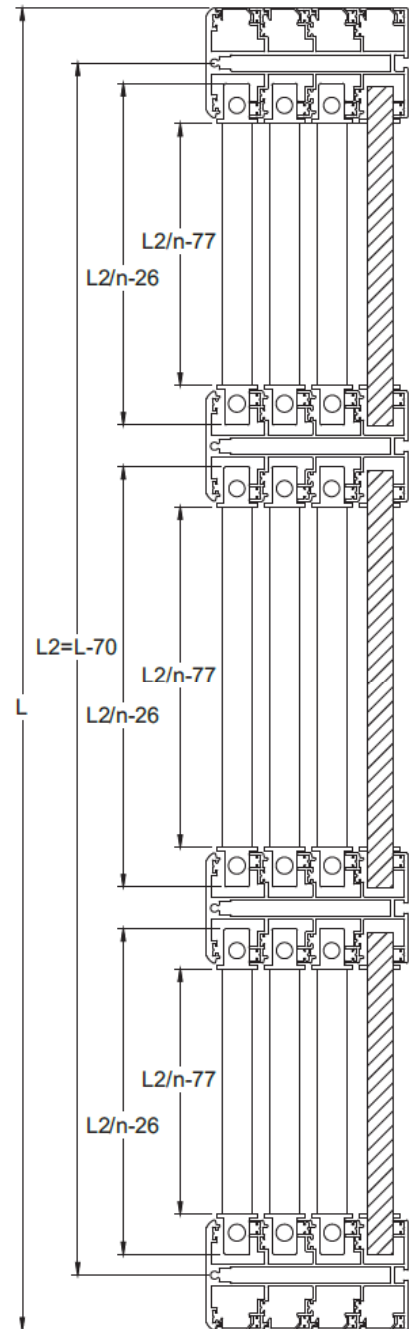
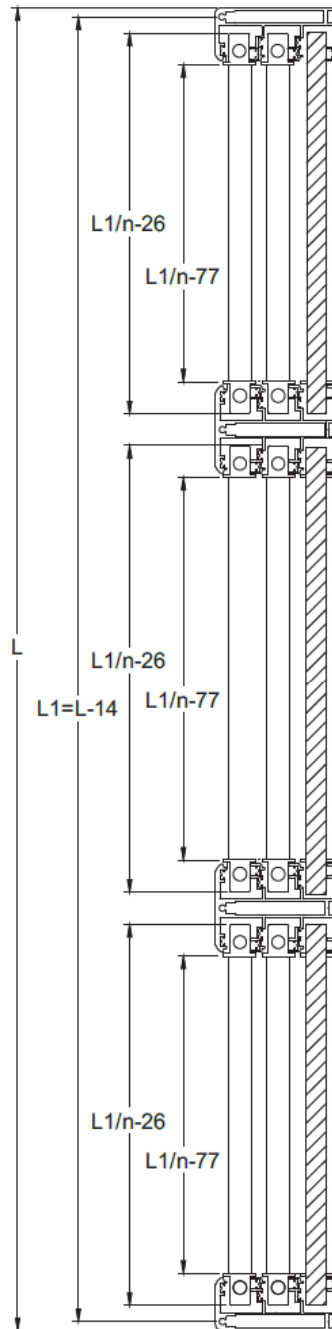
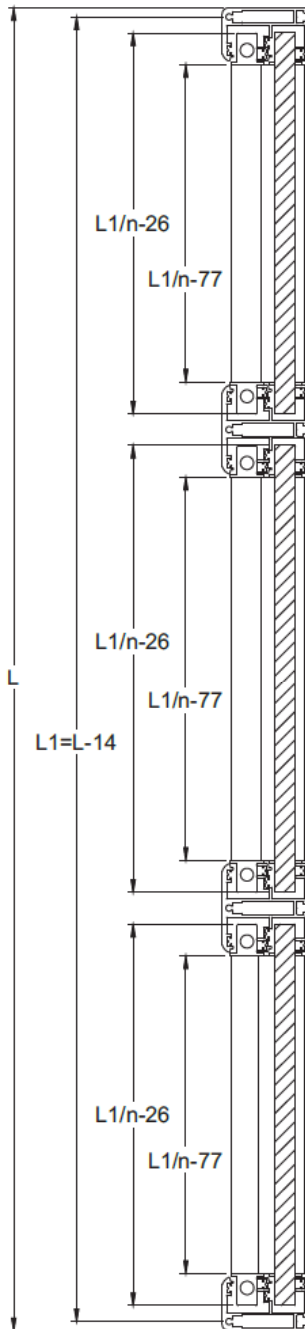

n = Numero de calles

$L1$ = Desde el eje al extremo

$L2$ = Desde el eje al extremo

PLANOS DE PERFIL TECHOS DESLIZANTES

2 Carriles manual

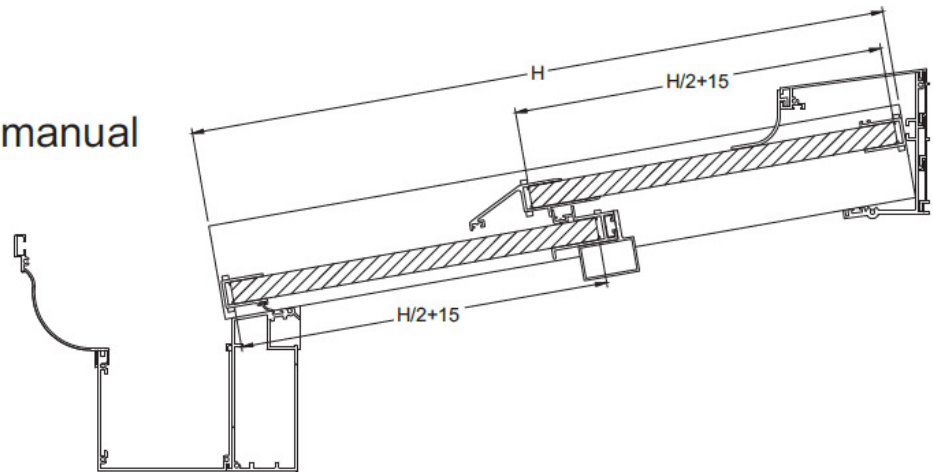

3 Carriles manual

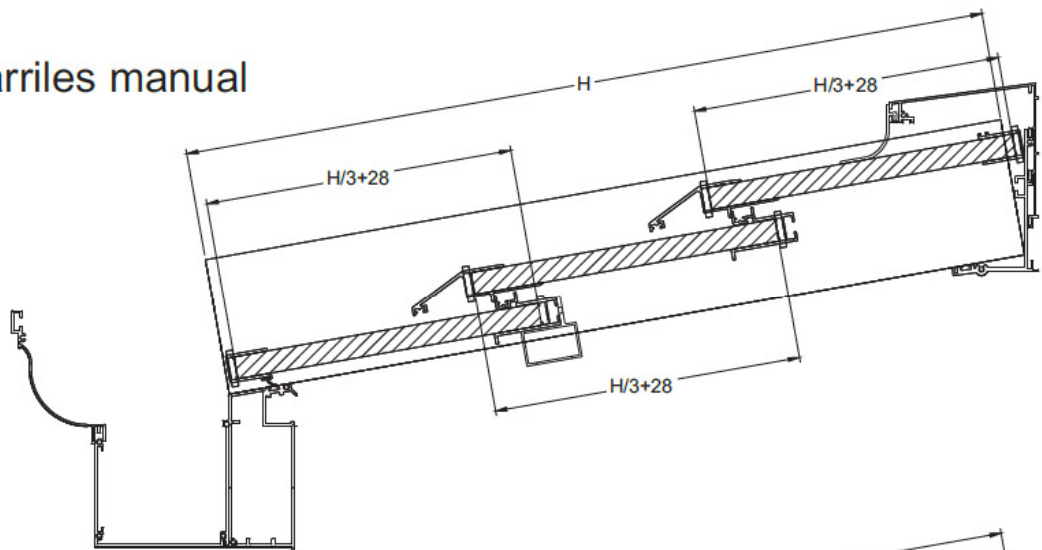

4 Carriles manual

