

HIERROS

ALUMINIOS

FF

S.A.

PLANO

MURO CORTINA

GUADALAJARA 15-6-08





PLANO MURO CORTINA GUADALAJARA 15-6-08

Características Técnicas

CARACTERÍSTICAS TÉCNICAS:

Sistema integral de Muro Cortina, que permite solucionar las distintas posibilidades constructivas y satisfacer las necesidades y particularidades de cada proyecto. Caracterizado por la facilidad de fabricación y montaje en obra.

- Misma perfilaría portante para realizar las distintas posibilidades constructivas "Muro cortina con tapetas" "Muro cortina de trama horizontal" "Muro Cortina Estructural".
- Perfiles en aluminio extruido aleación 6063 y tratamiento T-5 con tolerancias dimensionales según UNE-EN- 755-9.
- Sello de calidad QUALICOAT para el aluminio lacado.
- Sello de calidad EURAS-EWAA para aluminio anodinado.
- Rotura de puente térmico en estructura básica mediante perfil de p.v.c. aislante.
- Ventana proyectante al exterior también con rotura de puente térmico.
- Ventana proyectante oculta desde el exterior con zona oscura de vidrio minimizada, y sistema de cierre perimetral con varios puntos.
- Sistema de anclaje de M.C. a forjado con regulación tridimensional.
- Cara vista al interior de montantes y travesaños de 50 mm.

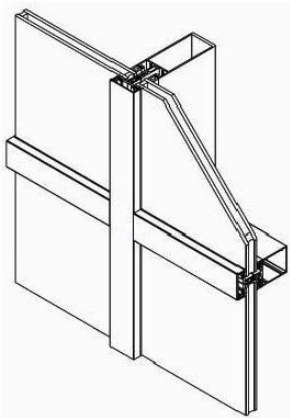

M.C. CON TAPETAS

- Permite insertar ventanas practicables de las series Itesal o ventana proyectante exterior propia del sistema
- Ventana proyectante sin decalaje de vidrio
- Acristalamiento de 6 a 34 mm

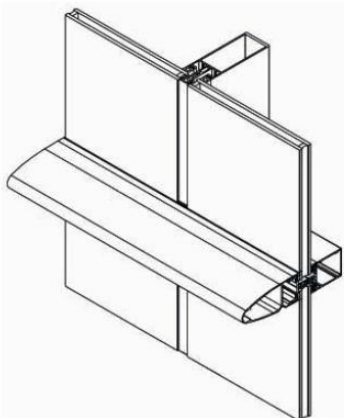

M.C. TRAMA HORIZ.

- Cierre entre vidrios en junta vertical con silicona o con goma.
- Posibilidad de disposición de alas tipo de avión en vertical y juntas entre vidrios en horizontal

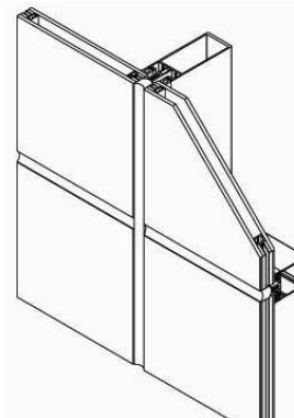

M.C. ESTRUCTURAL

- Vidrios y paneles sujetos mecánicamente a la estructura portante por medio de grapas colocadas directamente al intercalario del vidrio
- Perfilaría oculta por el exterior

HIERROS

ALUMINIOS

FF

S.A.

PLANO

MURO CORTINA

GUADALAJARA 15-6-08

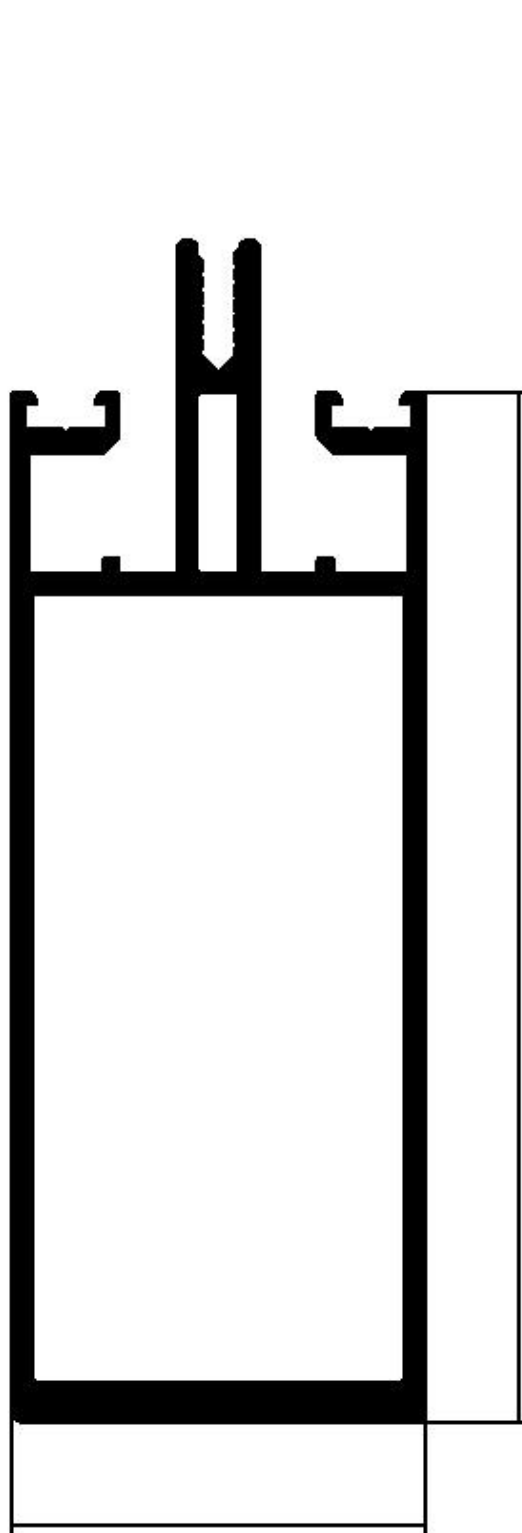

50

125

R. 64399

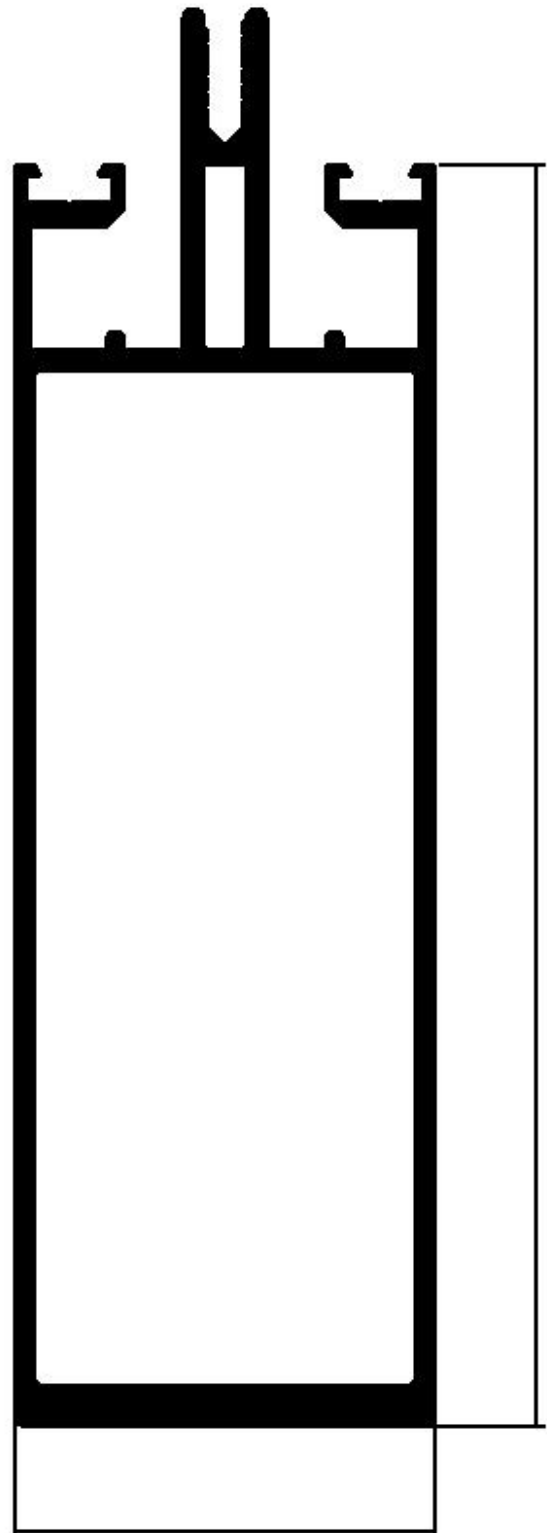

50

150

R. 64409

HIERROS

ALUMINIOS

FF

S.A.

PLANO

MURO CORTINA

GUADALAJARA 15-6-08

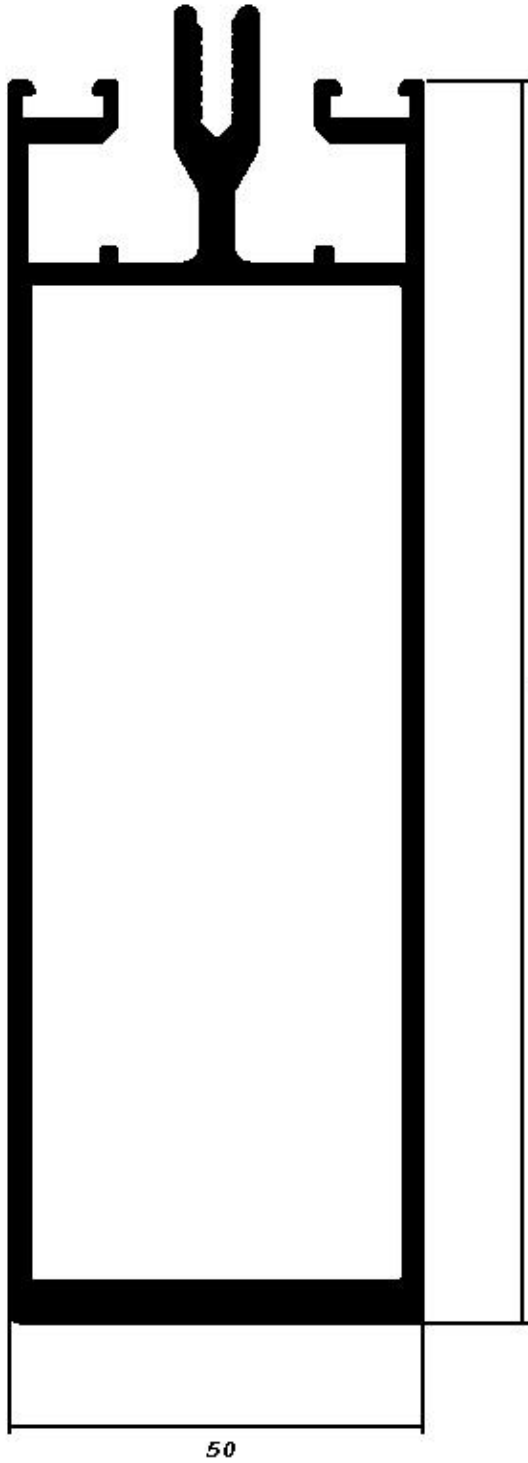

R. 64419

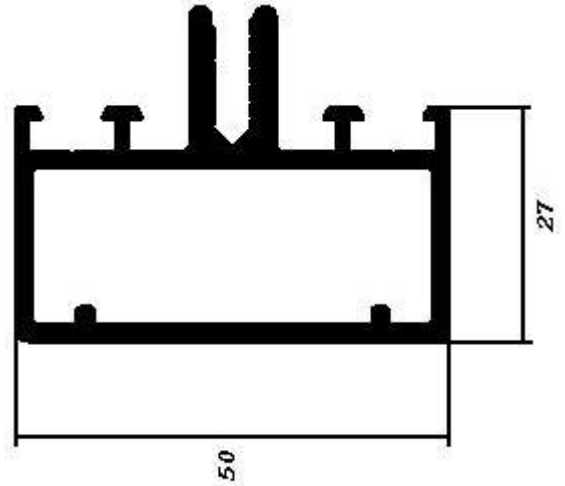

R. 64379

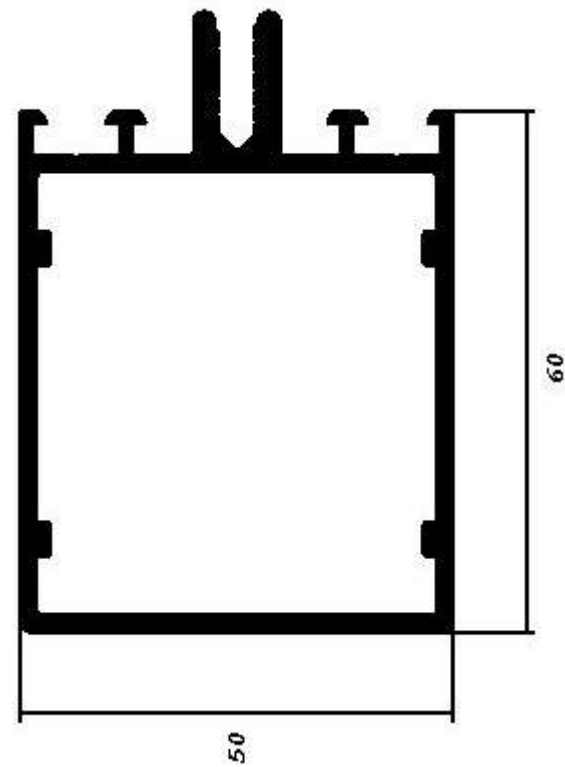

R. 64389

HIERROS

ALUMINIOS

FF

S.A.

PLANO

MURO CORTINA

GUADALAJARA 15-6-08

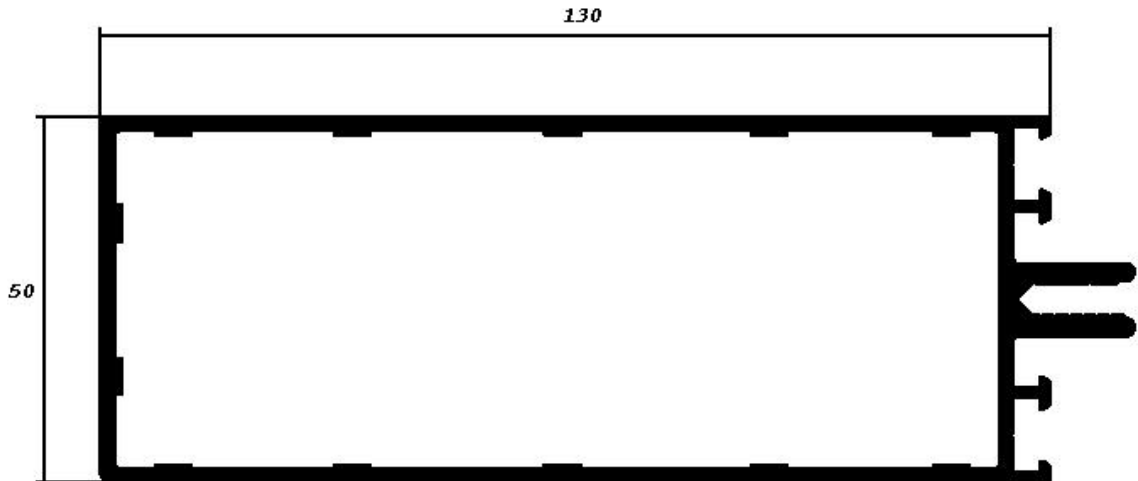

R. 64429

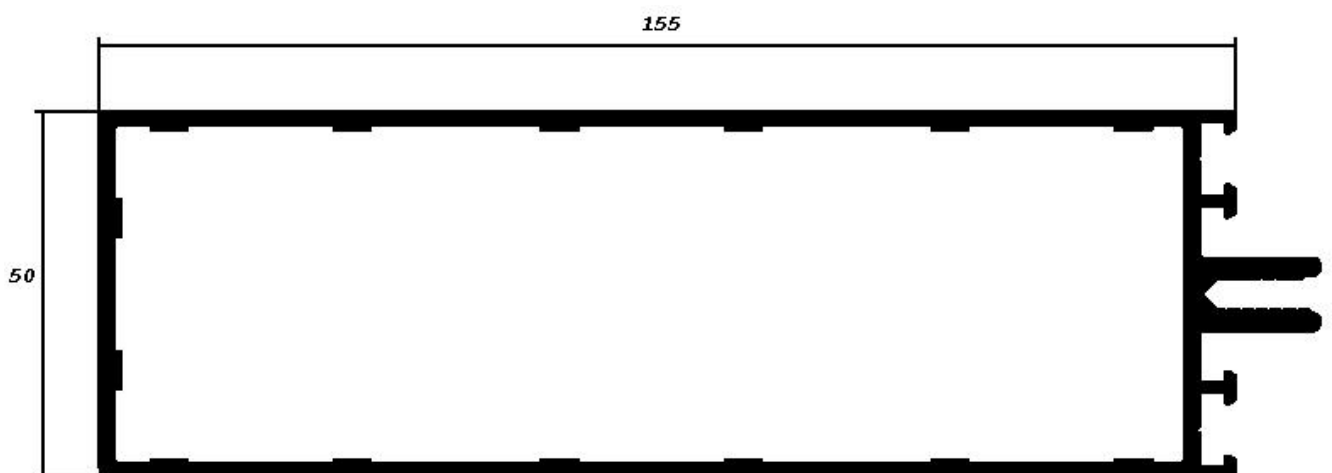

R. 64439

HIERROS

ALUMINIOS

FF

S.A.

PLANO

MURO CORTINA

GUADALAJARA 15-6-08

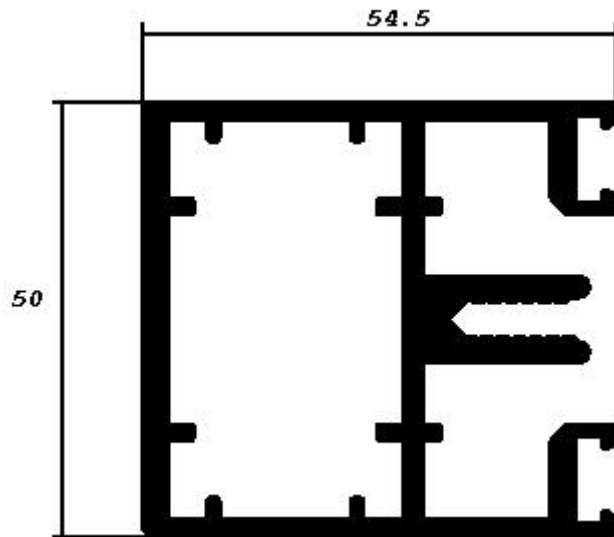

R. 64309

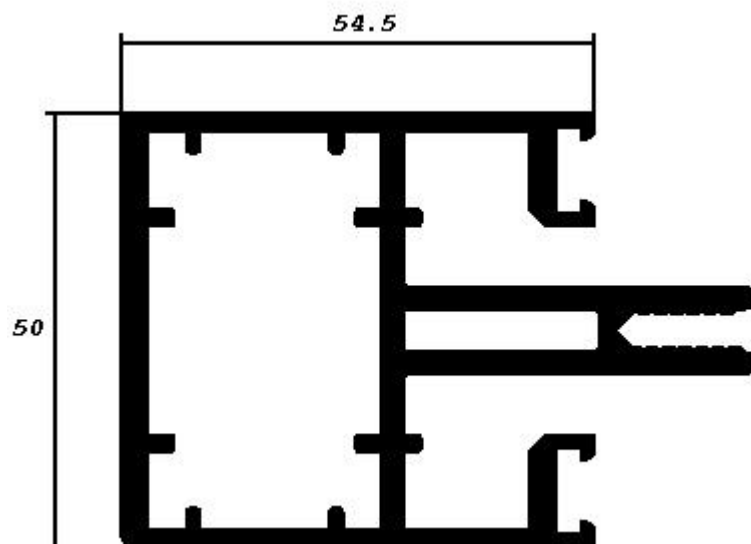

R. 64449

HIERROS

ALUMINIOS

FF

S.A.

PLANO

MURO CORTINA

GUADALAJARA 15-6-08

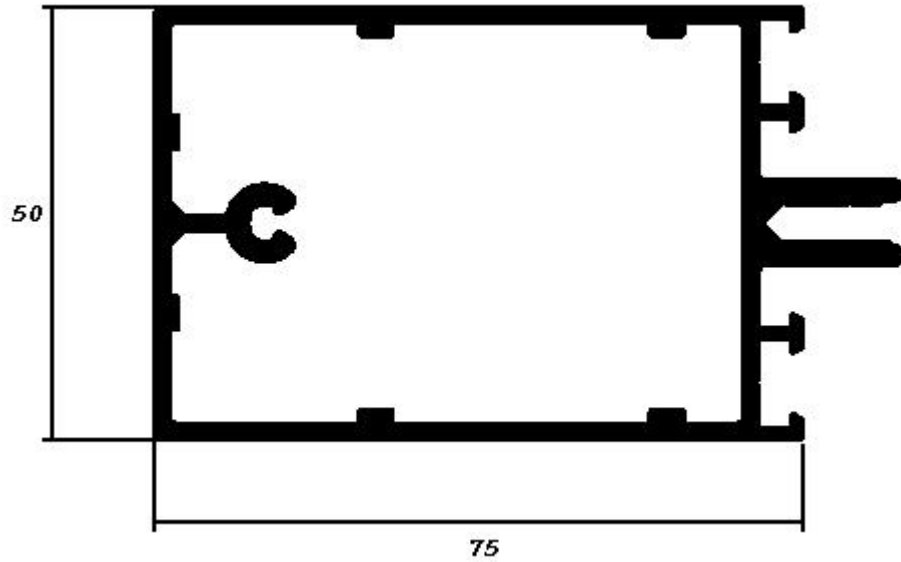

R. 64869

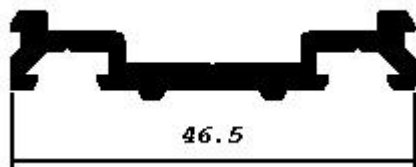

R. 64349

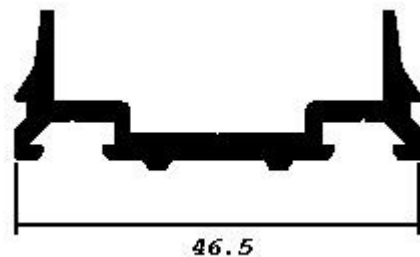

R. 64359

HIERROS

ALUMINIOS

FF

S.A.

PLANO

MURO CORTINA

GUADALAJARA 15-6-08

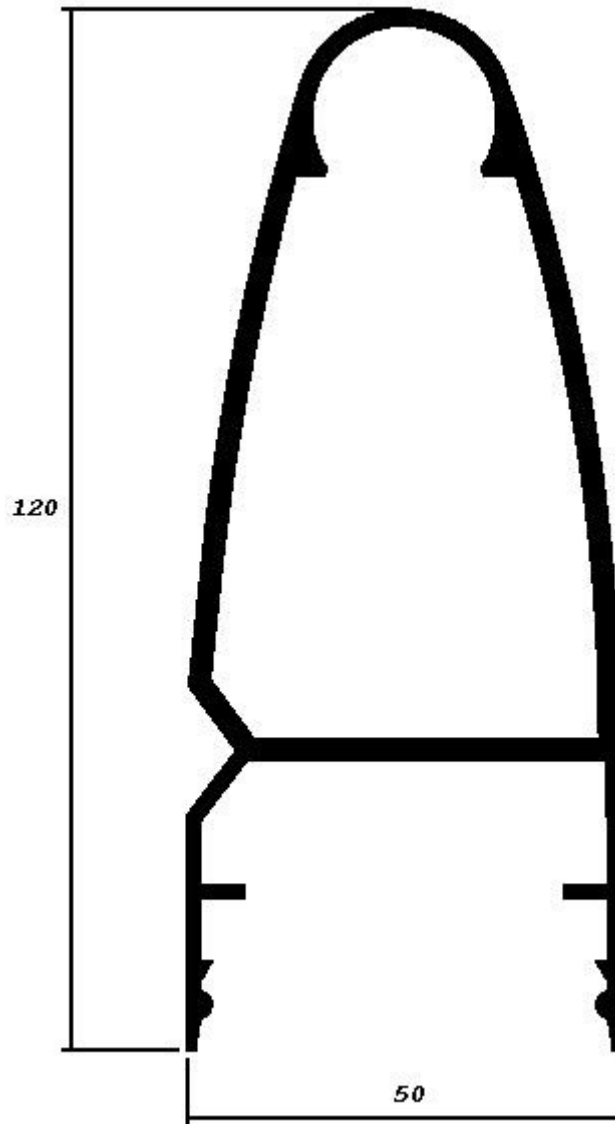

R. 64469



R. 64465

HIERROS

ALUMINIOS

FF

S.A.

PLANO

MURO CORTINA

GUADALAJARA 15-6-08

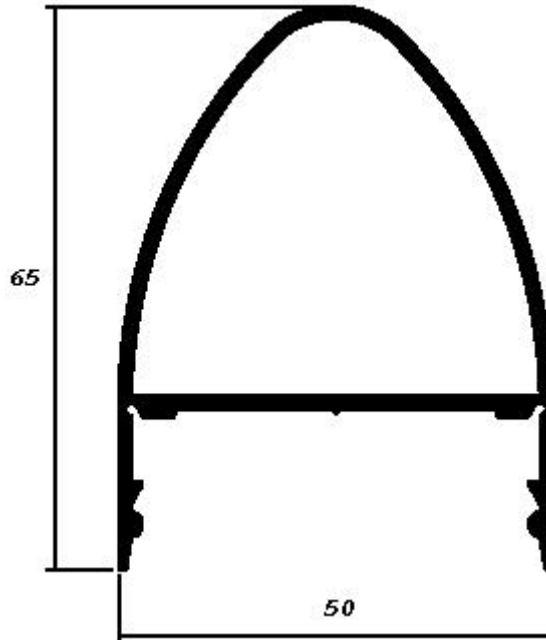

R. 64879

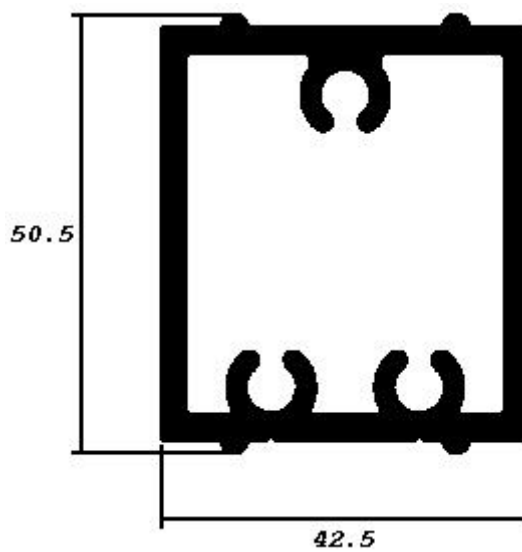

R. 64339

HIERROS

ALUMINIOS

FF

S.A.

PLANO

MURO CORTINA

GUADALAJARA 15-6-08

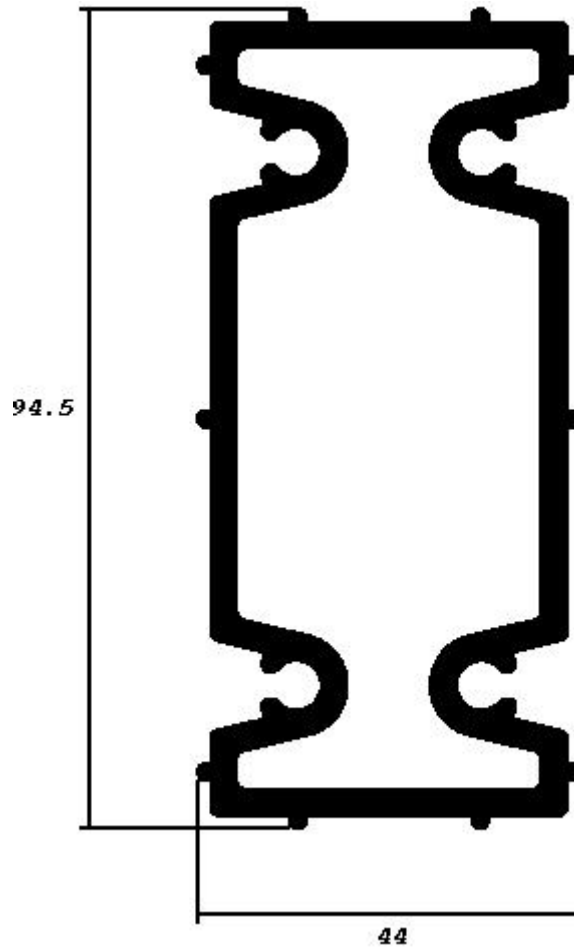

R. 64319

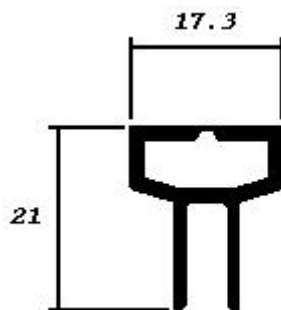

R. 64444

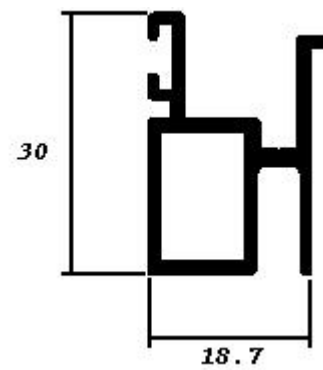

R. 64454

HIERROS

ALUMINIOS

FF

S.A.

PLANO

MURO CORTINA

GUADALAJARA 15-6-08

119.5

44

R. 64329

18

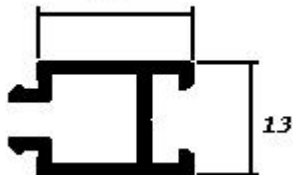

R. 64332

18.7

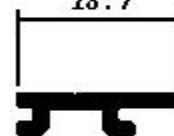

R. 64324

HIERROS

ALUMINIOS

FF

S.A.

PLANO

MURO CORTINA

GUADALAJARA 15-6-08

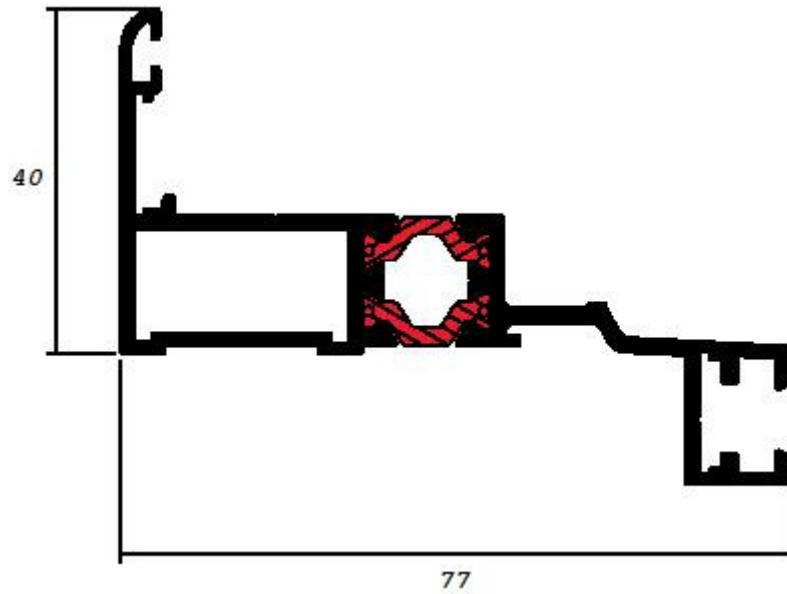

R. 64001

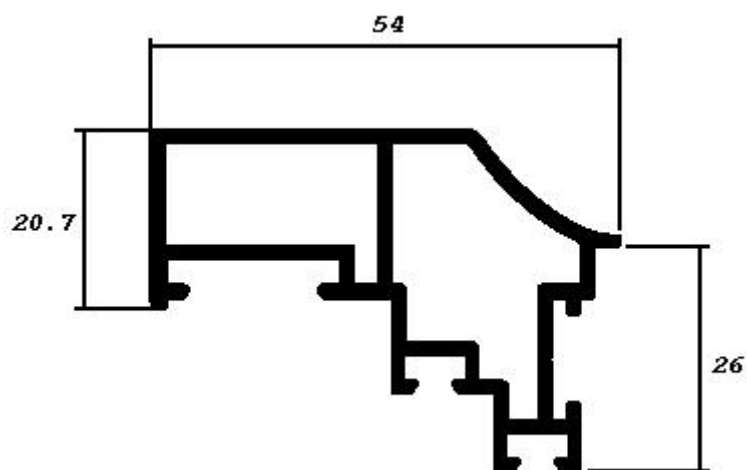

R. 64325

HIERROS**ALUMINIOS****FF****S.A.**

PLANO
MURO CORTINA
GUADALAJARA 15-6-08

Accesorios

	REFERENCIA	DENOMINACIÓN	OBSERVACIONES
		Conjunto cierre ventana proyectante	
	ACG 1000	- Cremona euro	- Posibilidad de colocar cremona ACG1024
	HC 44318	- Bloque de conexión	
	ACG 4030	- Rodillo de cierre regulable	
	HC 44324	- Cerradero de marco	
	ACG 4019	- Angulo de reenvío	A partir de 1100 de altura hoja
	HC 44342	- Juego de compás regulable 80 Kg	Para 80 Kg peso de hoja
	HC 44343	- Juego de compás regulable 130 Kg	Para 130 Kg peso de hoja Ambos con tomillería de fijación
	HC 44350	- Escuadra de Marco y Hoja ventana proyectante	
	AC 44608	- Escuadra alineamiento inox	
	HC 44354	- Escuadra para perfil sellado vidrio	
	HC 44356	- Escuadra intercalario vidrio	
	HC 44362	- Calce vidrio sobre travesaño	
	HC 44364	- Calce seguridad ventana proyectante	
	HC 44326	- Calce apoyo vidrio	

HIERROS





ALUMINIOS

FF

S.A.

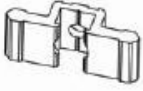
PLANO
MURO CORTINA
GUADALAJARA 15-6-08











Accesorios

	REFERENCIA	DENOMINACIÓN	OBSERVACIONES
	HC 44366	- Grapa doble sujeción vidrios muro estructural	
	HC 44367	- Grapa simple sujeción vidrios muro estructural	
	HC 44325	- Conjunto de anclaje básico	
	HC 45460	- Troquel para mecanizado M.C.	

HIERROS**ALUMINIOS****FF****S.A.**

PLANO
MURO CORTINA
GUADALAJARA 15-6-08

GOMAS

	REFERENCIA	DENOMINACIÓN	OBSERVACIONES
	HC 44332	- Goma montante vertical C-757	
	HC 44327	- Goma acristalar interior C-759	
	HC 44328	- Goma acristalar exterior C-756	
	HC 44626	- Goma interior marco ventana proyectante	
	HC 44338	- Goma de cierre hoja ventana proyectante	
	HC 44340	- Junta entre vidrios Trama Hor. C-806	
	HC 44346	- Poliamida separador de 16 R-205	Longitud 4 mts.
	HC 44347	- Poliamida separador de 19 R-230	Longitud 4 mts.
	HC 44348	- Poliamida separador de 24 R-187	Longitud 4 mts.
	HC 44339	- Cordón celular relleno de juntas	



PLANO
MURO CORTINA
GUADALAJARA 15-6-08

SECCIÓN VERTICAL FIJO VISIÓN - PANEL

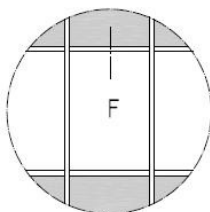
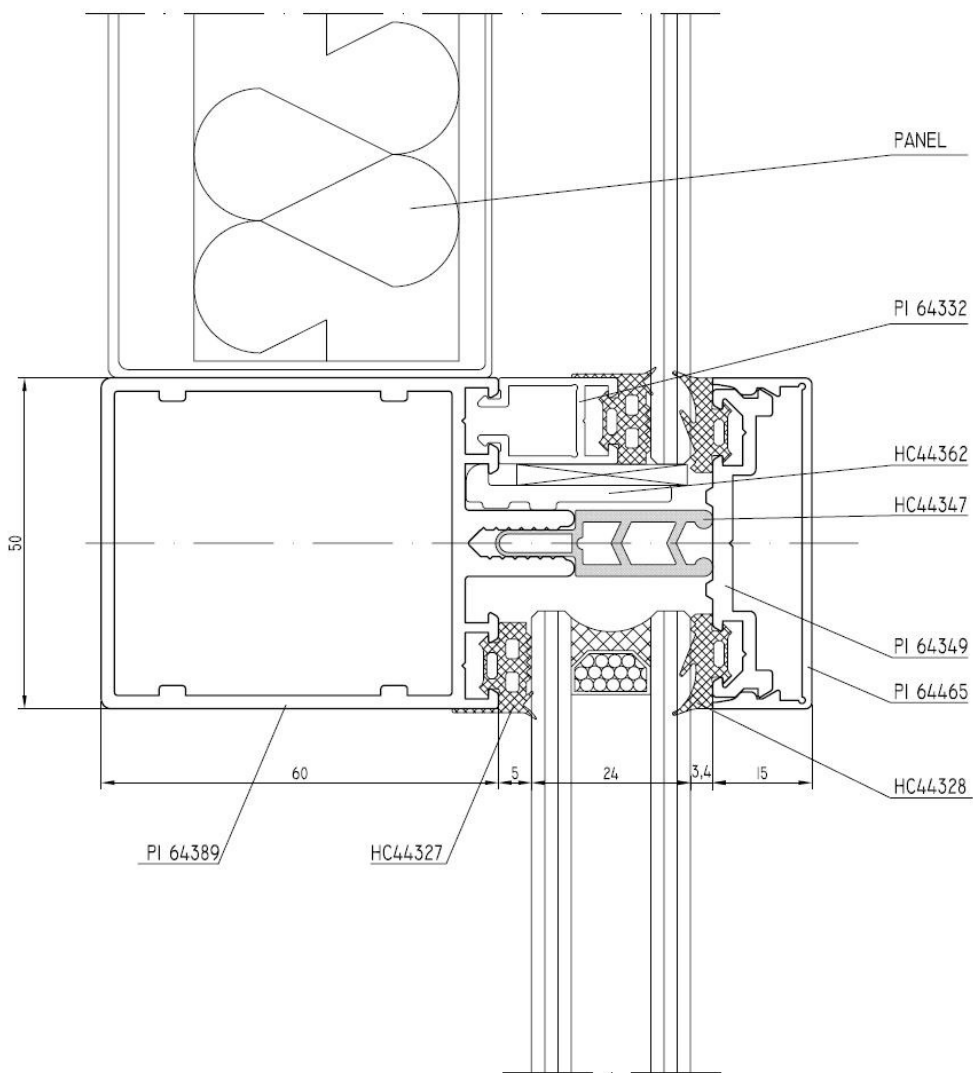

E : 1/1

HIERROS

ALUMINIOS

FF

S.A.

PLANO

MURO CORTINA

GUADALAJARA 15-6-08

SECCIÓN HORIZONTAL FIJO VISIÓN - VISIÓN

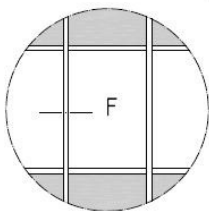
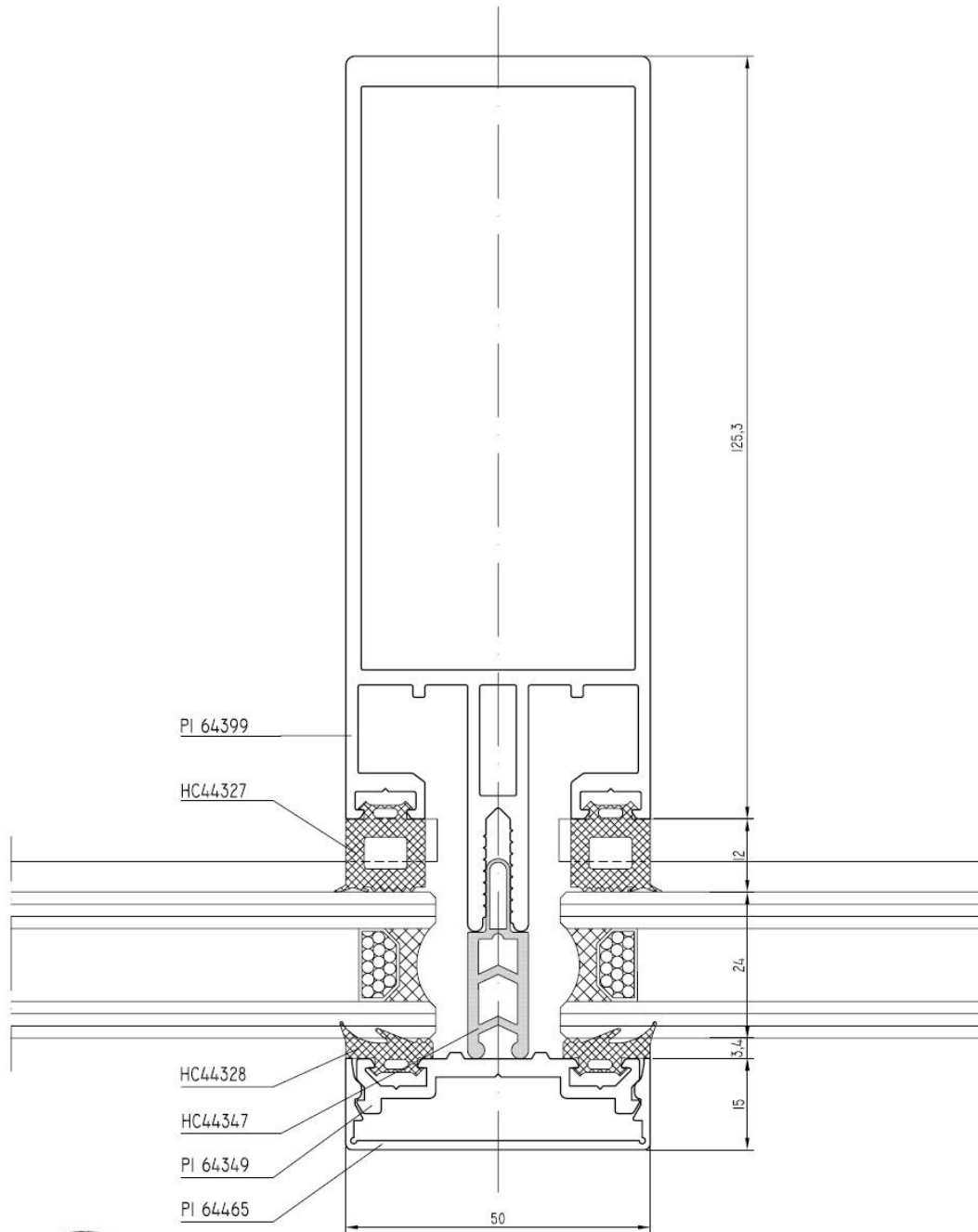

SECCIONES M.C. FIJO CON TAPETAS

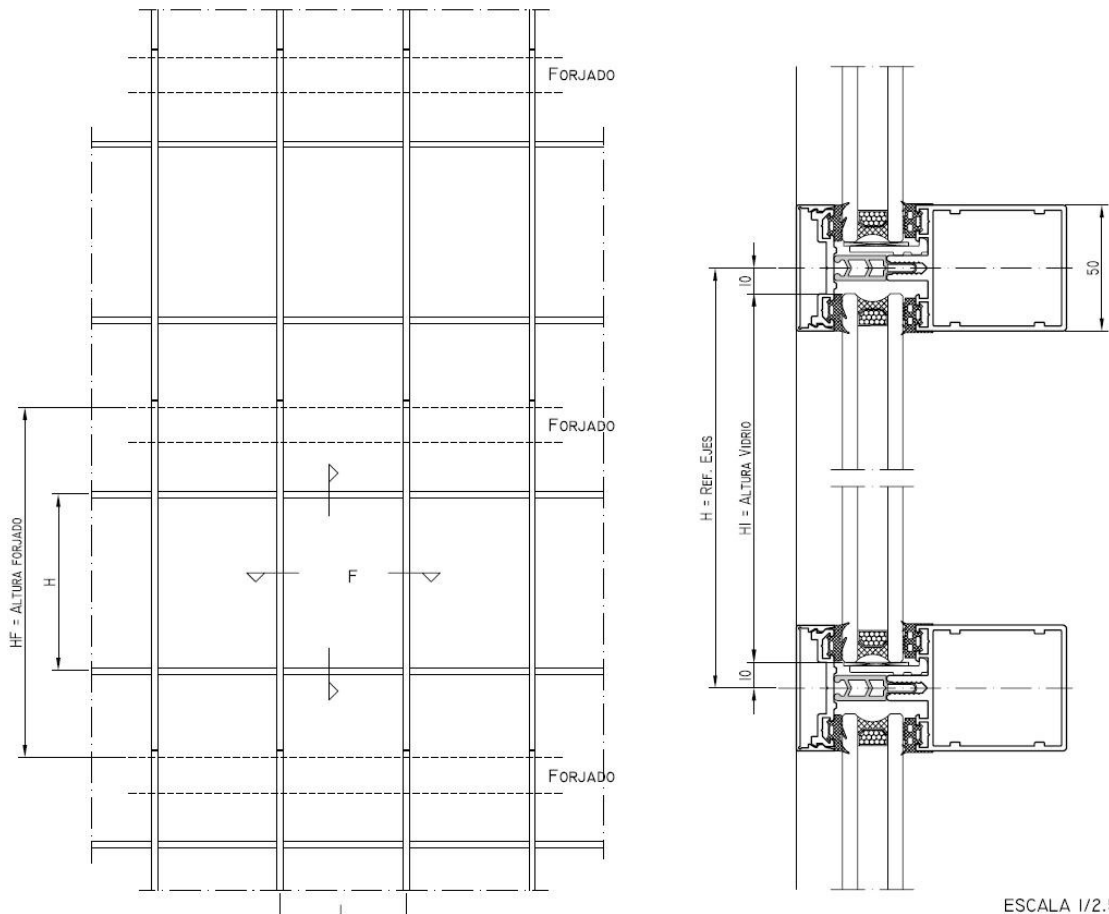

ESCALA 1/2.5

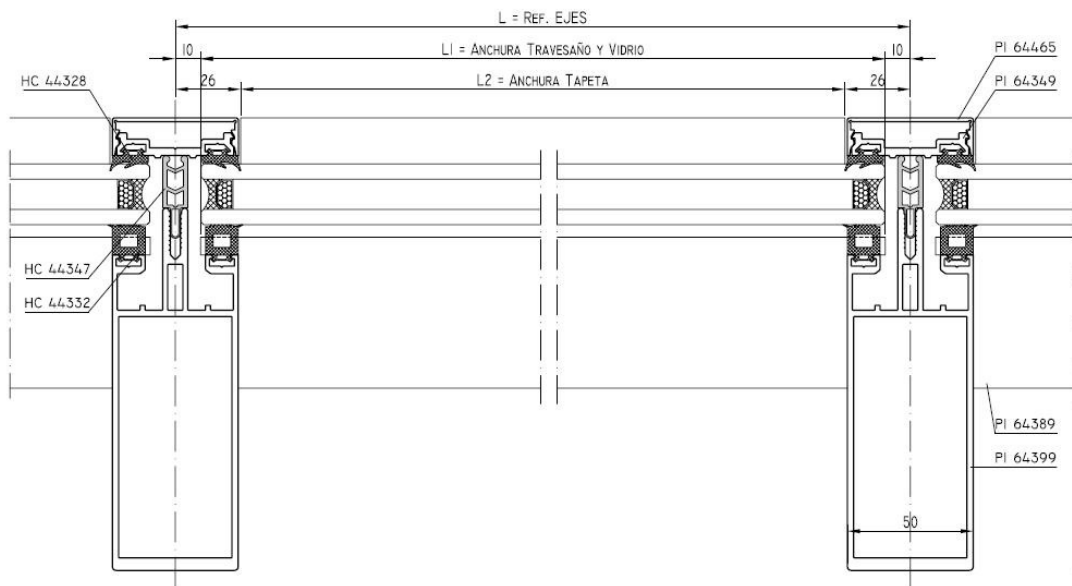

PLANO
MURO CORTINA
GUADALAJARA 15-6-08

SECCIONES VENTANA PROYECTANTE

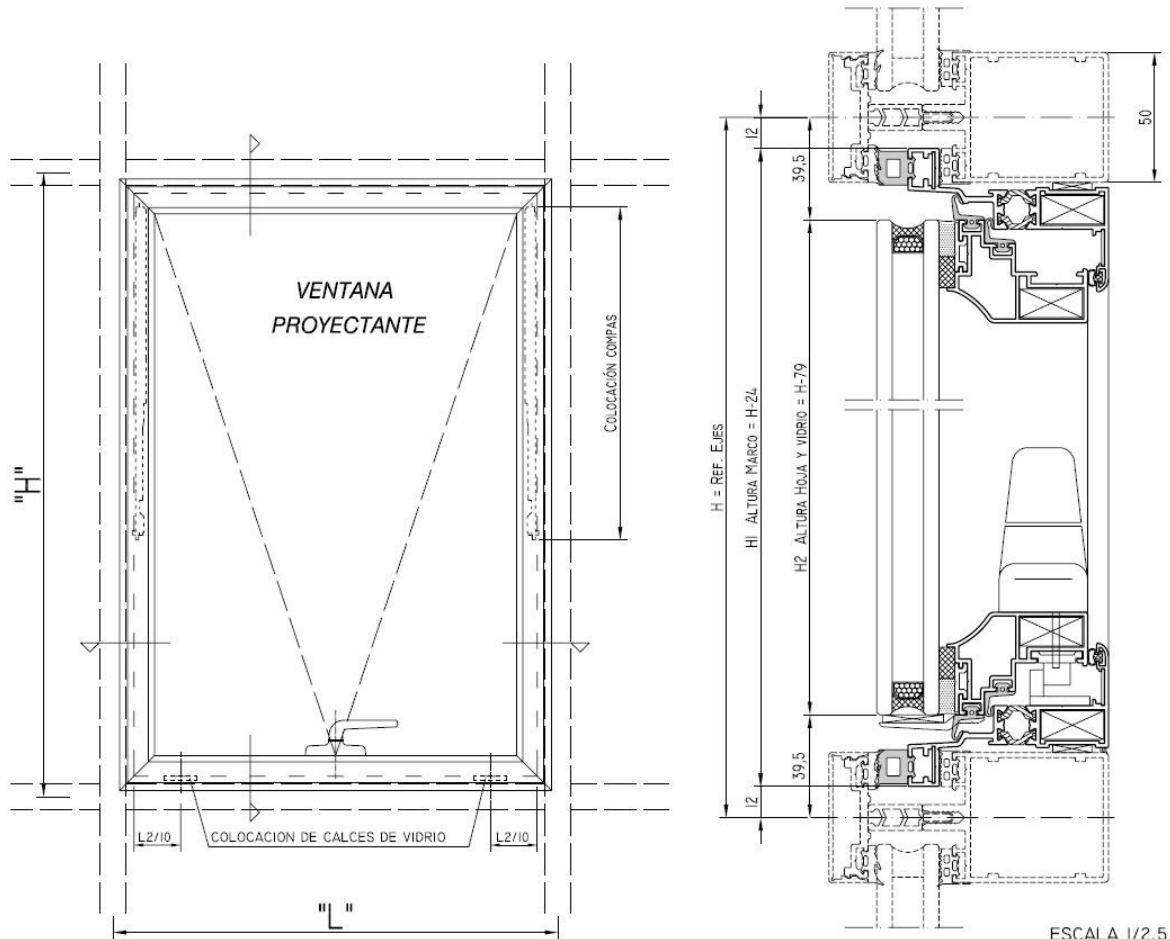

ESCALA 1/2.5

